

Perfetto: The Clear Choice For Professionals

Perfetto :

The instruments are manufactured from high quality stainless steel, and meet with the essential requirements of BS EN ISO 7153.



Perfetto Plus:

These are produced to the same high specification but with Tungsten Carbide Inserts fitted to either the cutting or gripping edges. This will give the instrument an even longer high performance life.



Perfetto Super Plus:

Titanium instrumentation designed to meet the needs of surgical procedures that require a precision featherweight touch or in a situation where only totally non-magnetic tools can be used.



Perfetto Diagnostic:

High quality hand held diagnostic equipment and instrumentation to meet the needs of modern medical demands.



Stainless steel

SURGICAL INSTRUMENTS are the most sophisticated feature in the modern surgery. They need to be precise, formulated from the right material, heat-treated and finished to the point in all respects. We try our best to produce the instruments to the above specifications in order to ensure that wherever our instruments are utilized, no danger accrues to the human life and the complexity it involves in bringing about the desired goal and achievements. We are presenting this catalogue with a hope that it would be an excellent guide to all our promoters and medical professionals the world over. A modern range of Surgical Instruments is exhibited in this catalogue for you to choose the best and the most convenient items to suit your way of processing in the medical profession and in order to achieve the highest result. Our location in the center of Sialkot city in Pakistan which is known the world over for this profession and in the supply of Surgical Instruments in particular. We have at our disposal expertise whose professional approach and technical abilities in the modern Surgery make it possible for us to acclaim the quality Instruments. We would always remain indebted in the support given to us by our promoters to help us in the marketing of our stainless steel Surgical Instruments in their proximity with pride and honor. We pledge and undertake to serve even more in the years ahead to our quality minded promoters, with highest standard and correct designing of the Instruments. Though the catalogue covers a wide range of Instruments but we are open to welcome you enquiries for the instruments not listed in the catalogue. Our endeavor and earnest desire to maintain the present prices but due to the universal economic conditions it has remained beyond our control to make adjustments where necessary. We hope that this point would be appreciated in the right earnest.



- Perfetto* :..... Die Instrumente sind aus hochwertigem Edelstahl gefertigt. und mit den grundlegenden Anforderungen der BS EN ISO 7153 erfüllen.
Perfetto Plus:..... Diese werden nach den gleichen hohen Spezifikation hergestellt, aber mit Hartmetall Fügt entweder mit dem Schneiden oder Griffkanten ausgestattet. Dies wird das Instrument eine noch längere Hochleistungs Leben.
Perfetto Super Plus:..... Titanium Instrumente entwickelt, um die Bedürfnisse der sugical Verfahren zu treffen, dass erfordern eine Präzision Federgewicht touch oder in einer Situation, wo nur völlig nichtmagnetischen Werkzeuge können verwendet werden.
Perfetto Diagnostic:.. Hochwertige Hand diagnostische Geräte und Instrumente zu treffen die Bedürfnisse der modernen medizinischen Anforderungen.

- Perfetto* :..... Les instruments sont fabriqués à partir de haute qualité en acier inoxydable. et répondre aux exigences essentielles de la norme BS EN ISO 7153.
Perfetto Plus:..... Ces produits sont fabriqués selon les mêmes spécifications mais avec grande carbure de tungstène Inserts monté soit sur la coupe ou les bords de préhension. Cela vous donnera l'instrument une durée de vie plus élevée des performances encore.
Perfetto Super Plus:.. L'instrumentation de titane conçu pour répondre aux besoins des procédures sugical que nécessitent une touche de précision plume ou dans une situation où seulement totalement non magnétiques outils peuvent être utilisés
Perfetto Diagnostic:.. Main de haute qualité a tenu matériel de diagnostic et d'instrumentation pour répondre les besoins des exigences modernes médicaux.

- Perfetto* :..... Instrumenty wykonane sa z wysokiej jakosci stali nierdzewnej. i spotkac sie z zasadniczymi wymaganiami BS EN ISO 7153.
Perfetto Plus:..... Sa one wytwarzane w tym samym wysokich parametrach z weglika wolframu, ale Plytki zamontowane albo ciecia lub krawedzie chwytajace. To daje instrument nawet dluzej High Life wydajnos.
Perfetto Super Plus:..... Oprzyrzadowanie Titanium zaprojektowany w celu zaspokojenia potrzeb sugical procedur wymagaja precyzji piorkowej dotyk lub w sytuacji, gdy tylko calkowicie niemagnetyczne narzedzia moga byc uzywane..
Perfetto Diagnostic:.. Wysoka jakosc hand odbylo sprzetu diagnostycznego i oprzyrzadowanie do spelnienia potrzeb nowoczesnej medycyny zadan.

- Perfetto* :..... Gli strumenti sono realizzati in acciaio inox di alta qualità. e soddisfare i requisiti essenziali della norma BS EN ISO 7153.
Perfetto Plus:..... Questi sono prodotti per la stessa specifica elevata, ma con carburo di tungsteno inserti montati sia il taglio o bordi di presa. Questo vi darà lo strumento una vita ancora più lunga ad alte prestazioni.
Perfetto Super Plus:.. Strumentazione titanio progettato per soddisfare le esigenze delle procedure sugical che richiedono un tocco piuma di precisione o in una situazione in cui gli strumenti non magnetici possono essere utilizzati solo totalmente.
Perfetto Diagnostic:.. Mano di alta qualità ha tenuto attrezzature diagnostiche e di strumentazione per soddisfare le esigenze delle esigenze mediche moderne.

Percussion Hammers Page 1

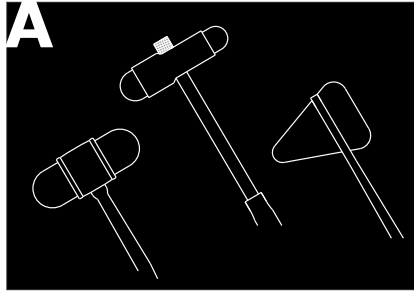

Scalpel Handles Page 4

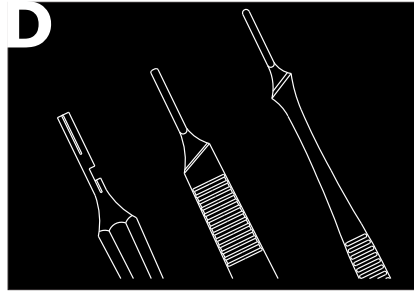

Forceps & Needle Holders Page 15 - 22

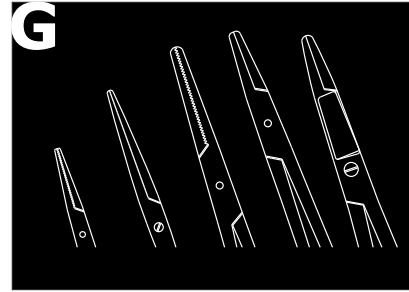

Bone, Plaster & Post Mortem Instruments. Page 27 - 32

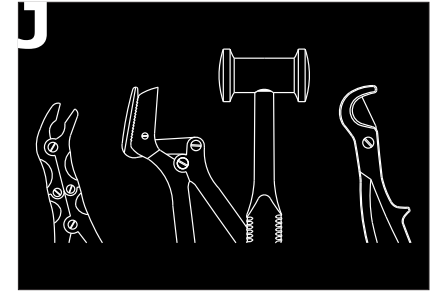

Tuning Forks Page 2

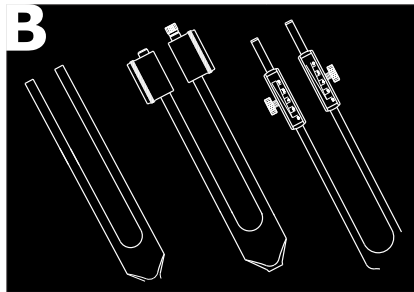

Scissors Page 5 - 9

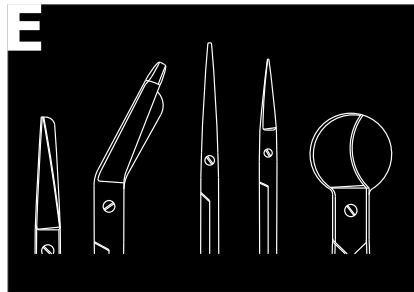

Retractors Page 23 - 24

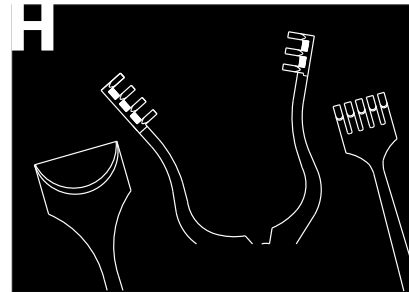

Nail Cutters, Nippers & Scissors Page 33 - 34

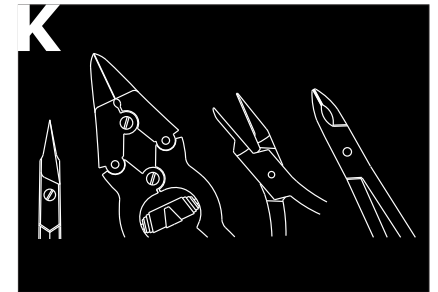

Laryngoscopes Page 3

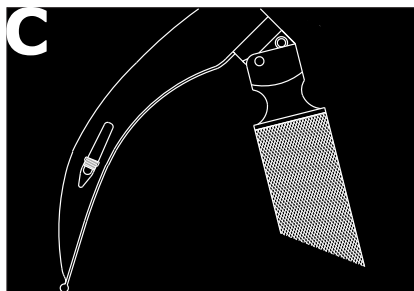

Dissecting & Tissue Forceps Page 10 - 14

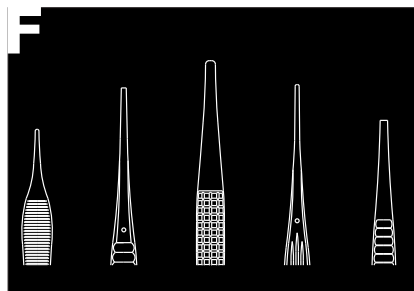

Suction Instruments Page 25 - 26

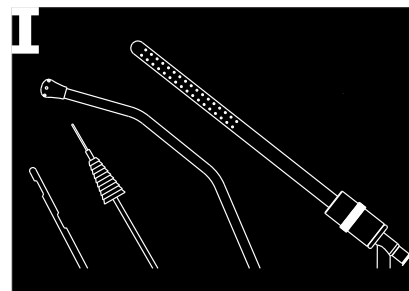

Dental Instruments Page 35 - 40



A

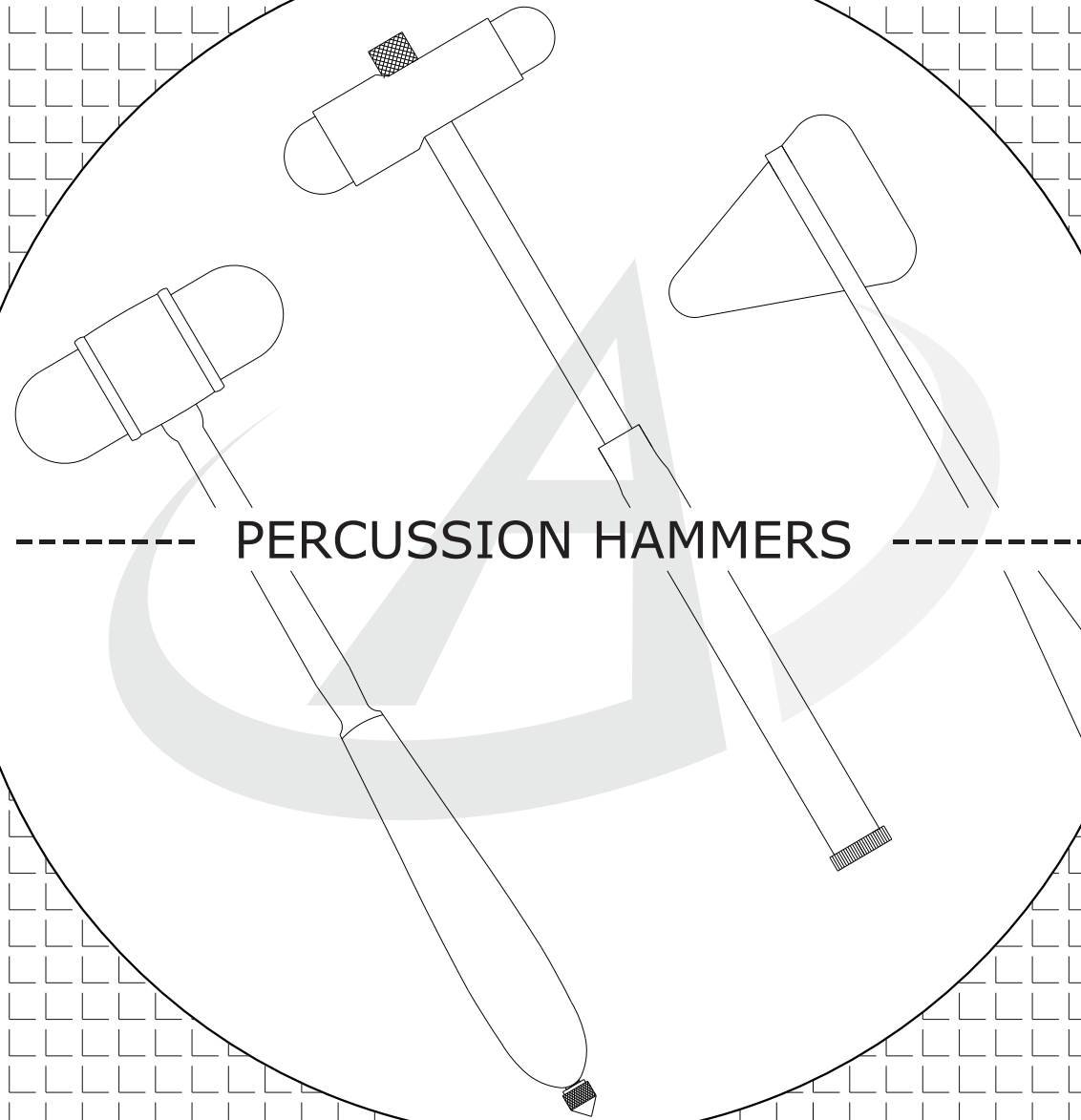

B

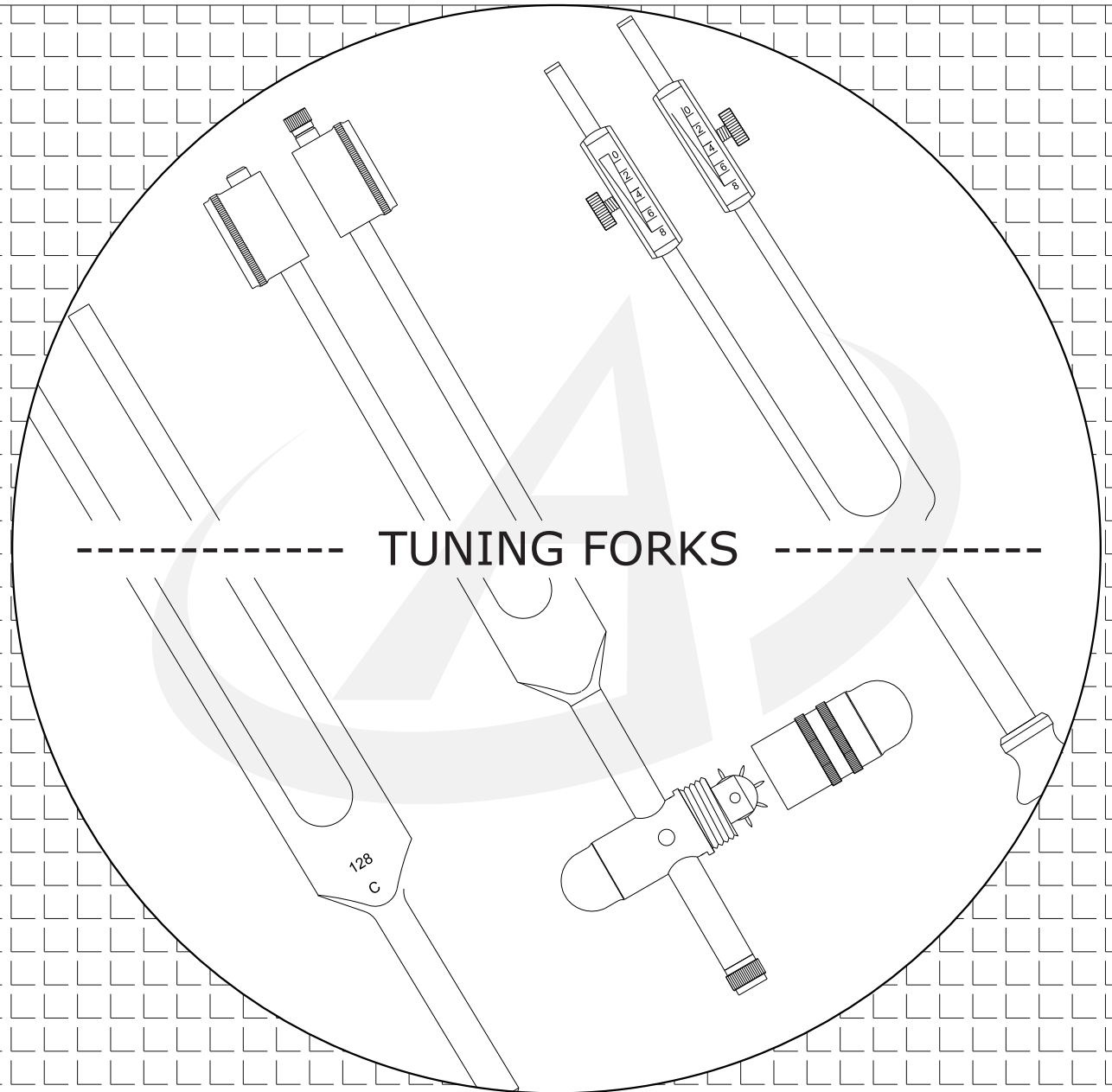

TUNING FORKS



LARYNGOSCOPES HANDLES AND BLADES

D

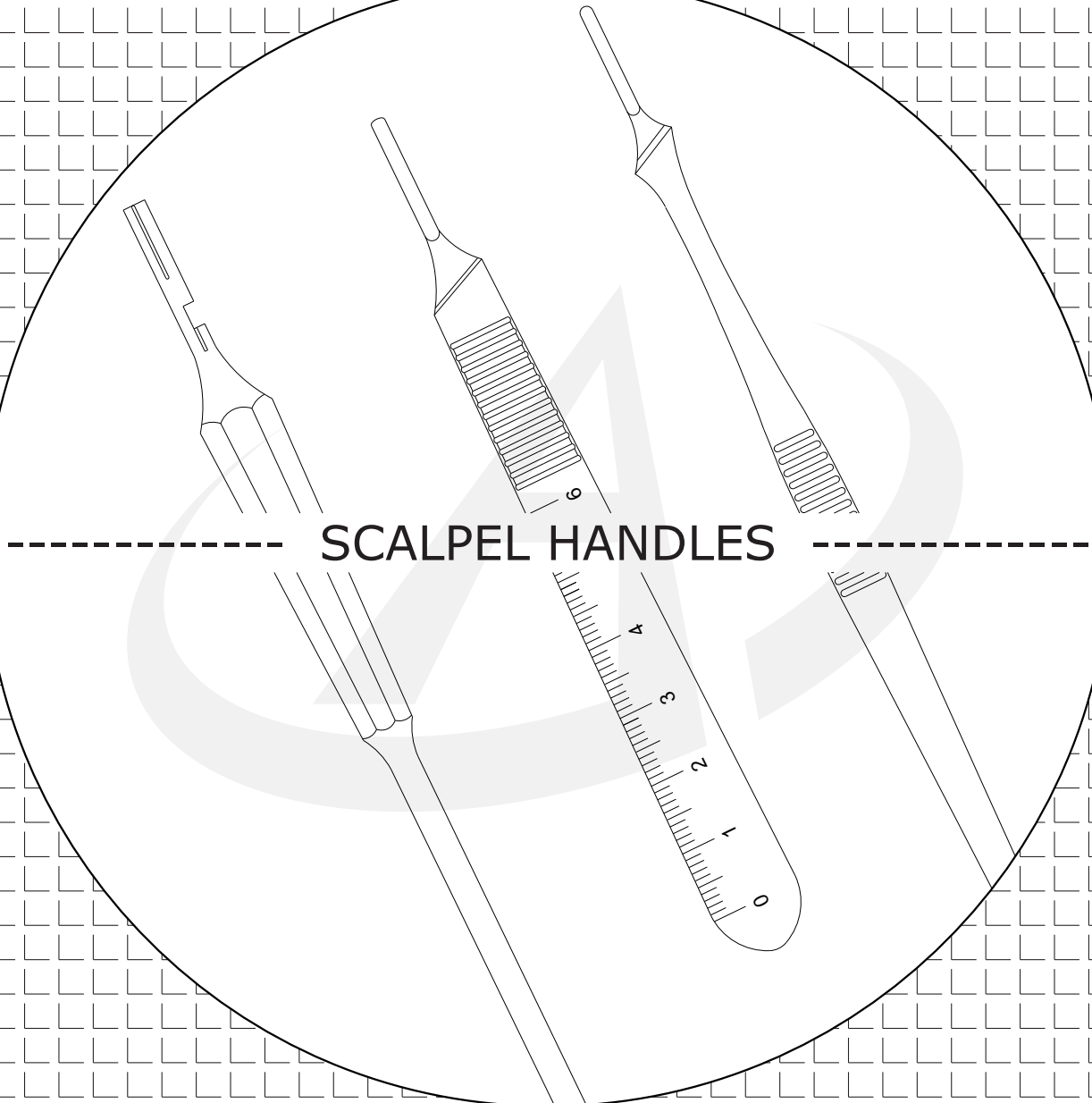

E

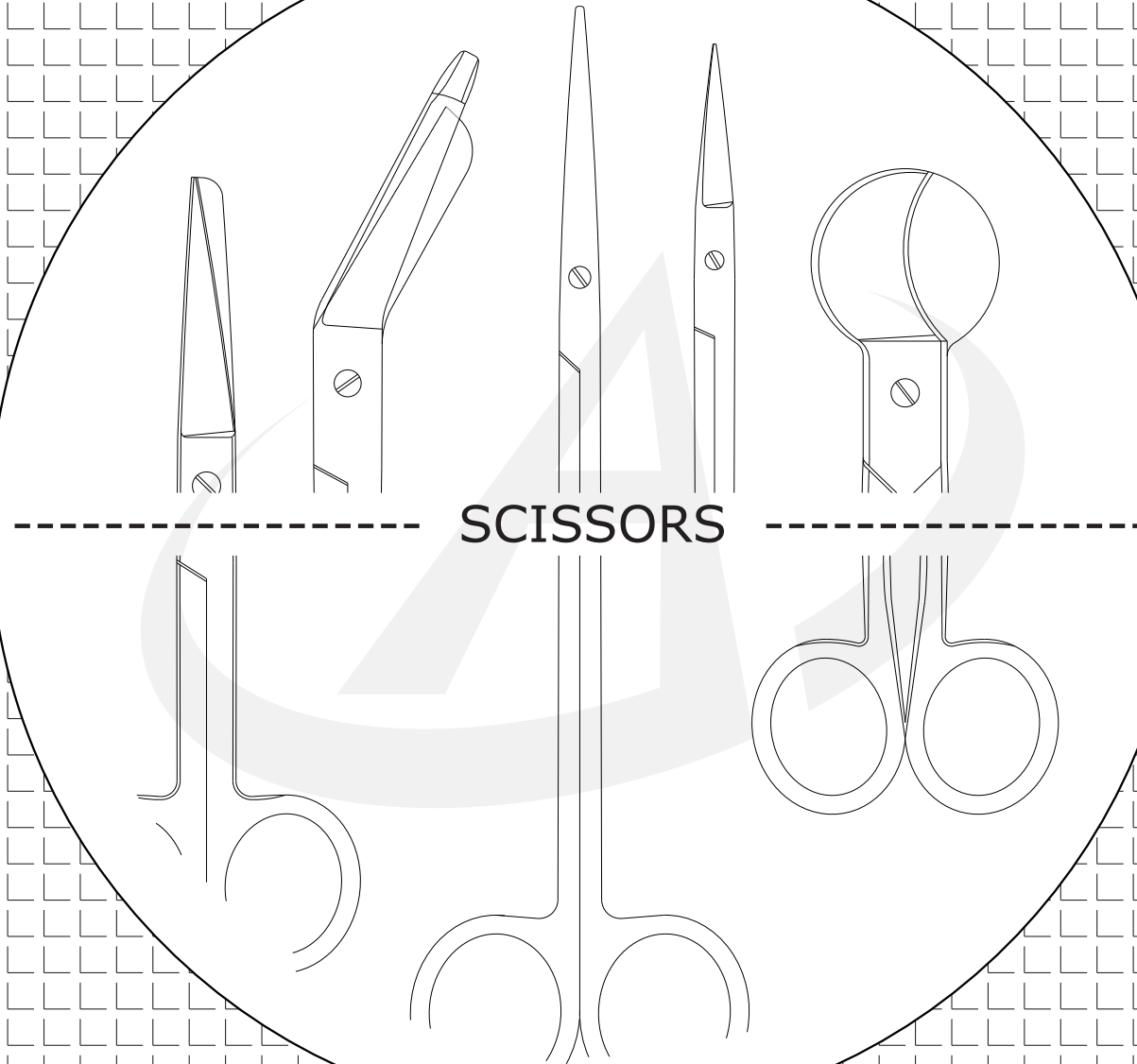

F

----DISSECTING AND TISSUE FORCEPS ----

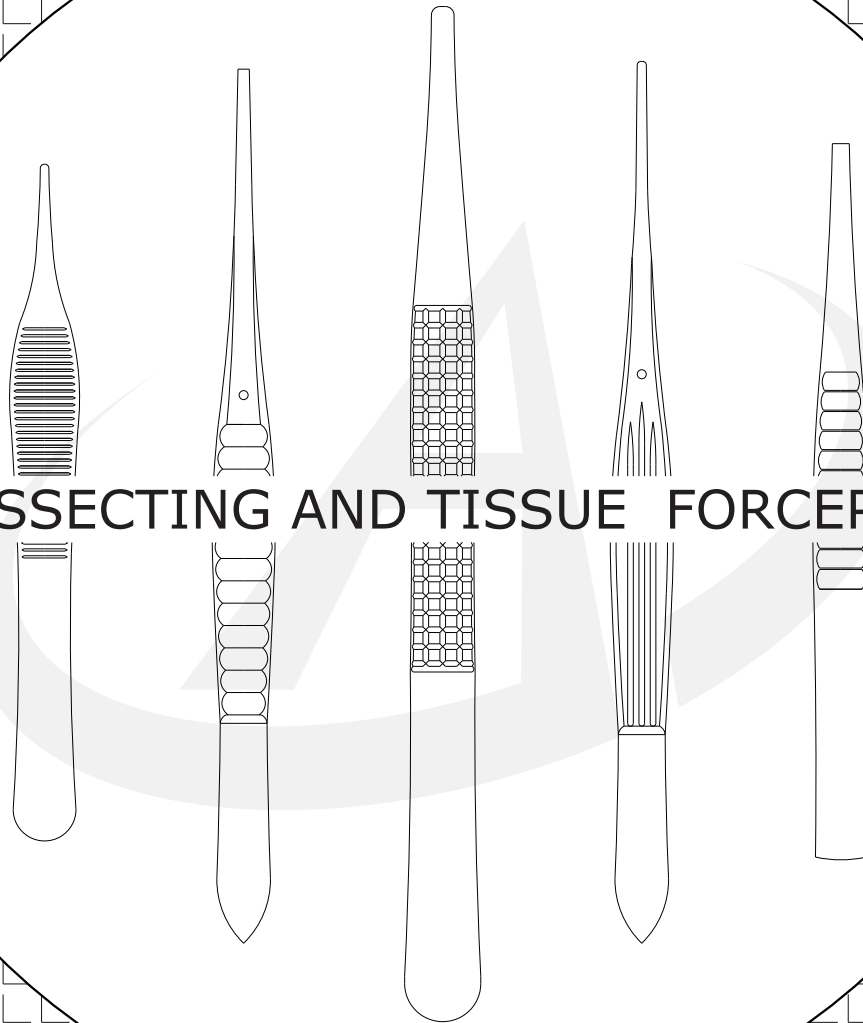

G

----- **FORCEPS AND NEEDLE HOLDERS** -----

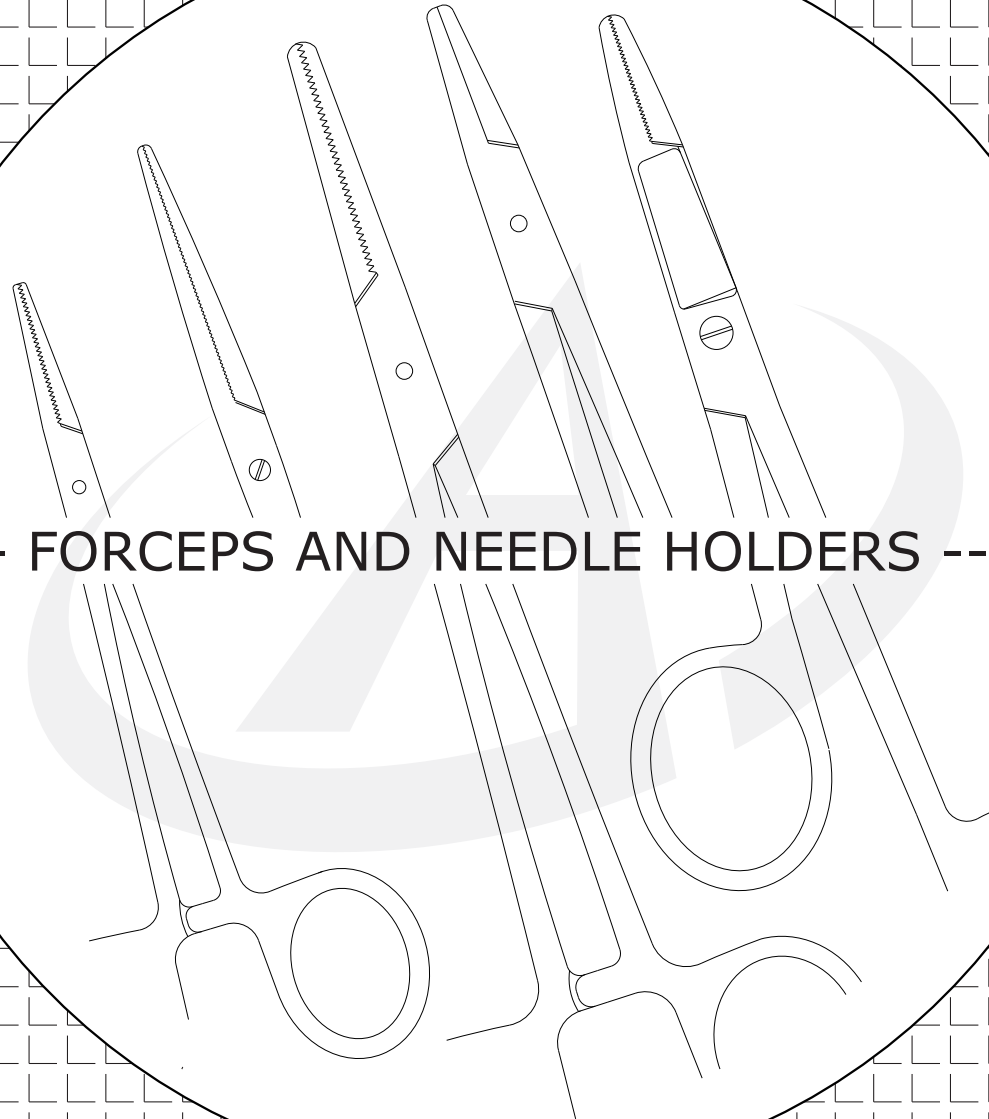

H

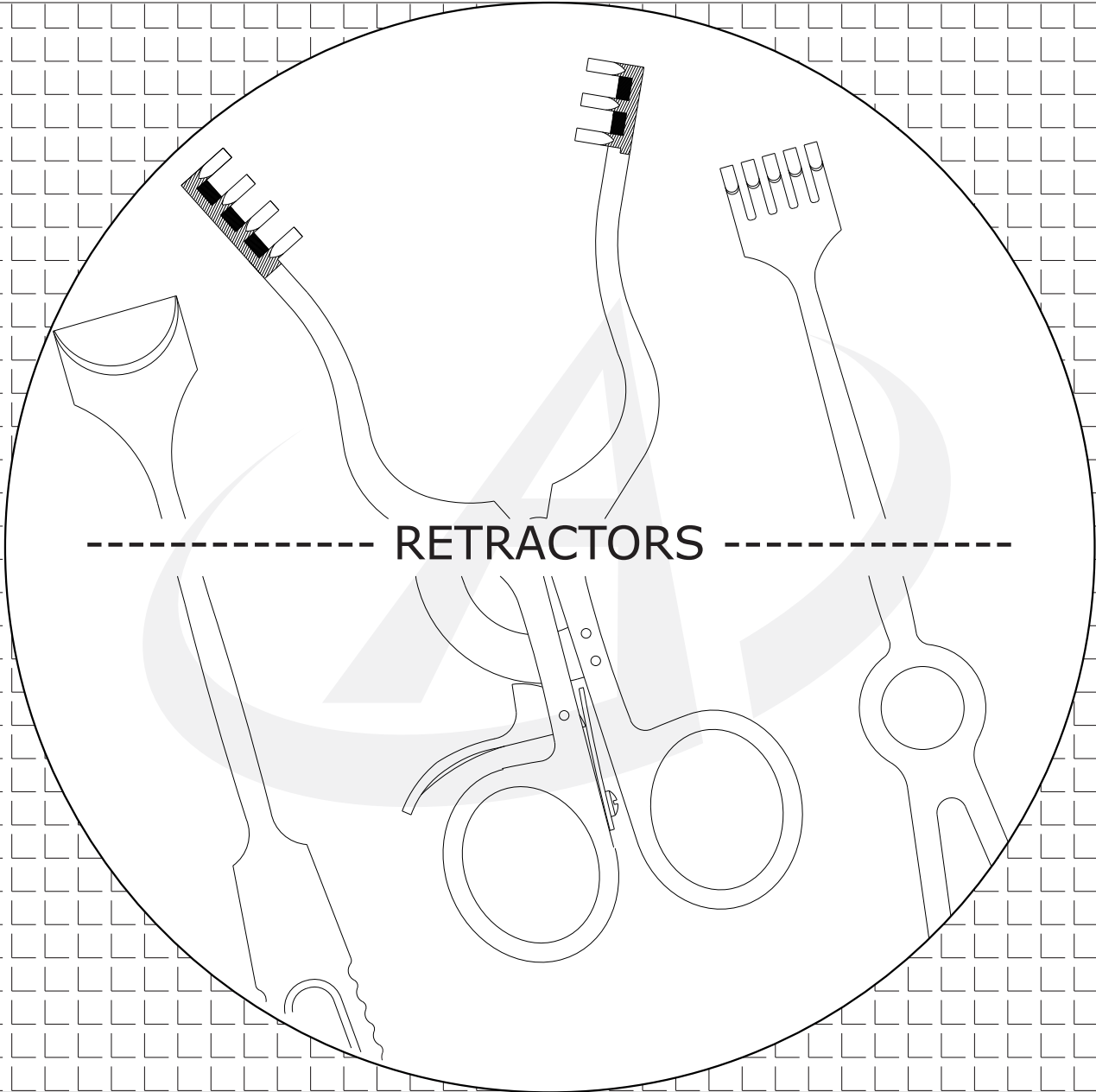

I

----- SUCTION INSTRUMENTS -----

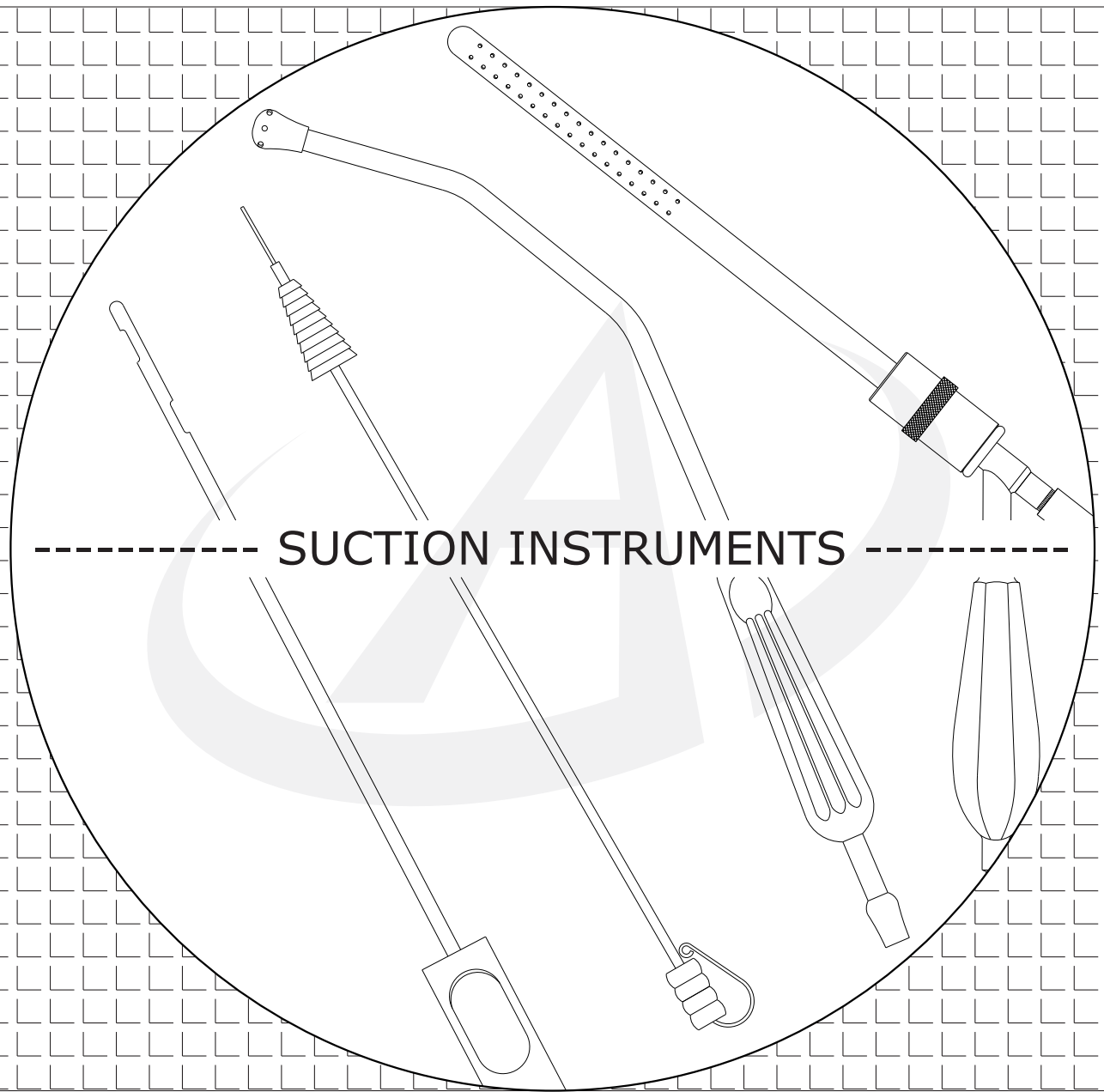

J

BONE, PLASTER & POST MORTEM INSTRUMENTS

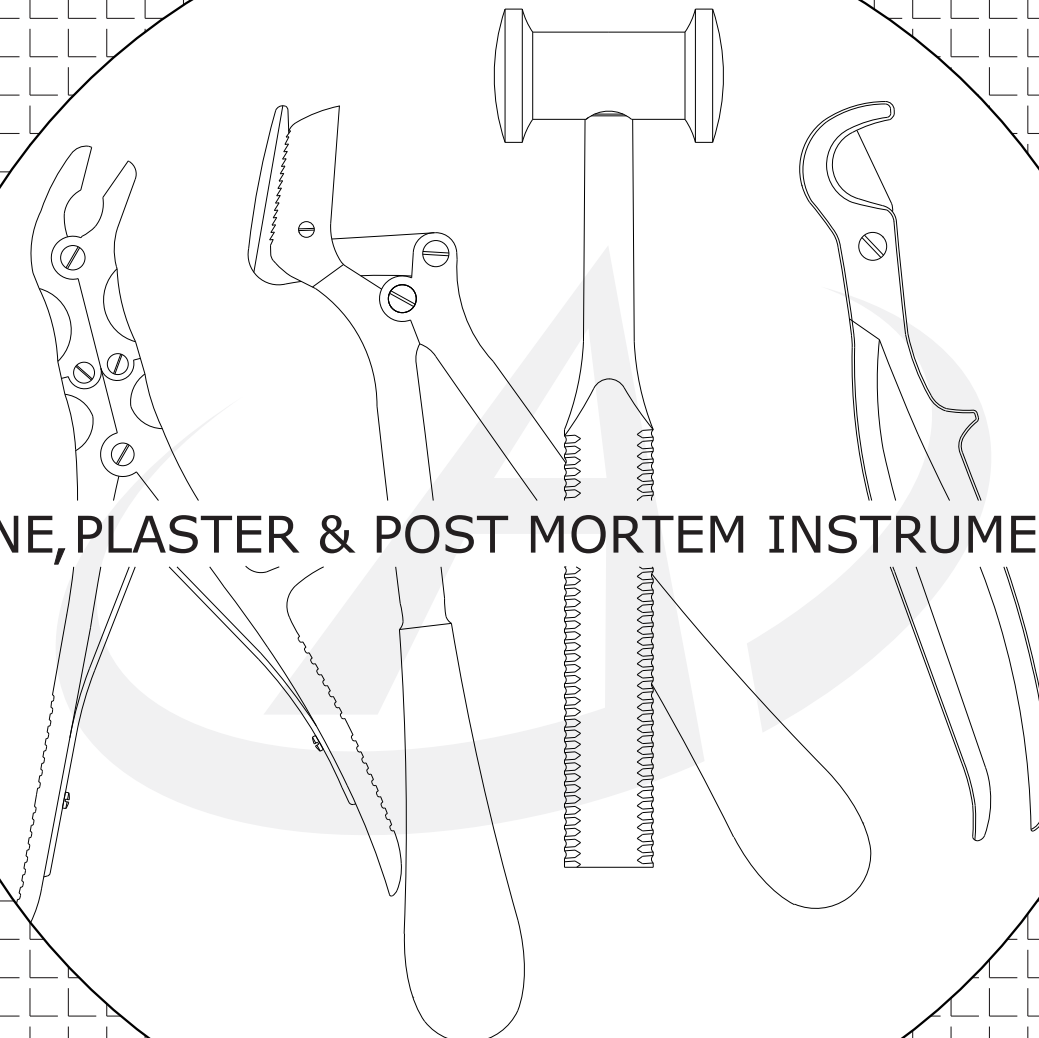

K

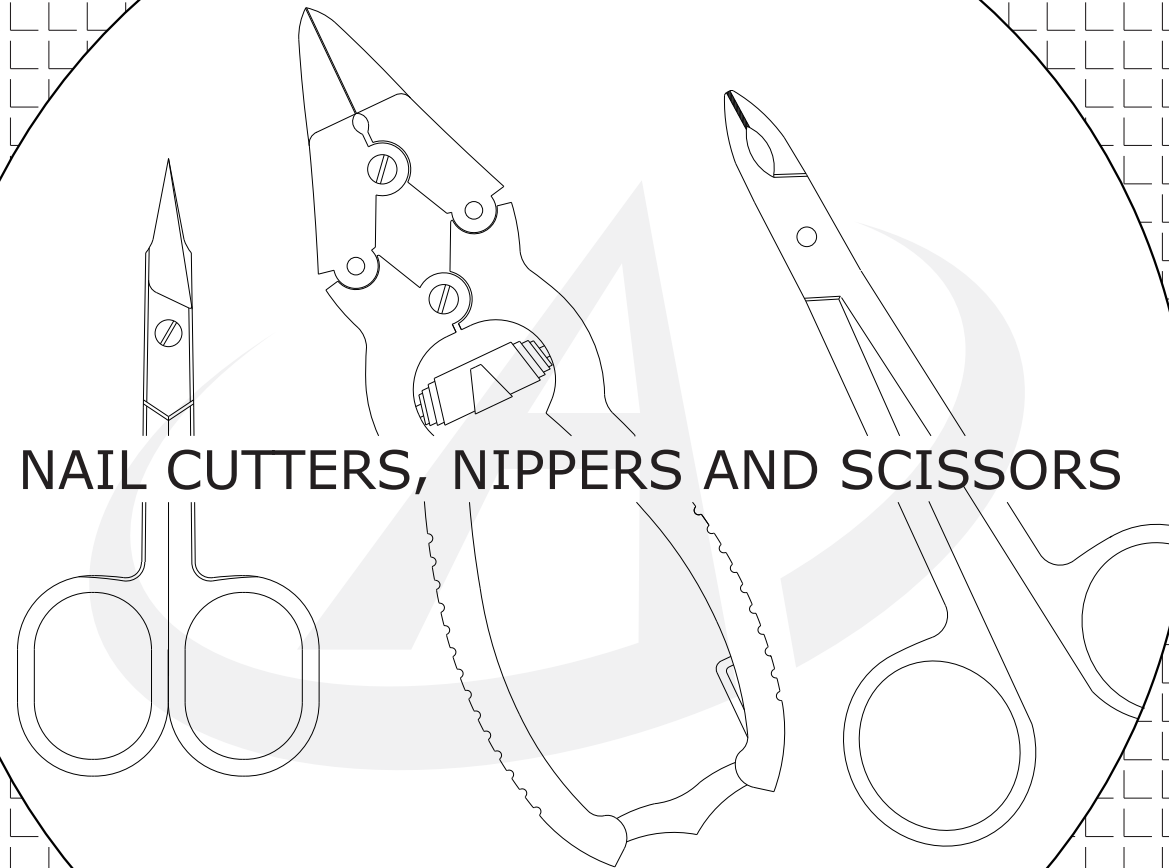

NAIL CUTTERS, NIPPERS AND SCISSORS

L

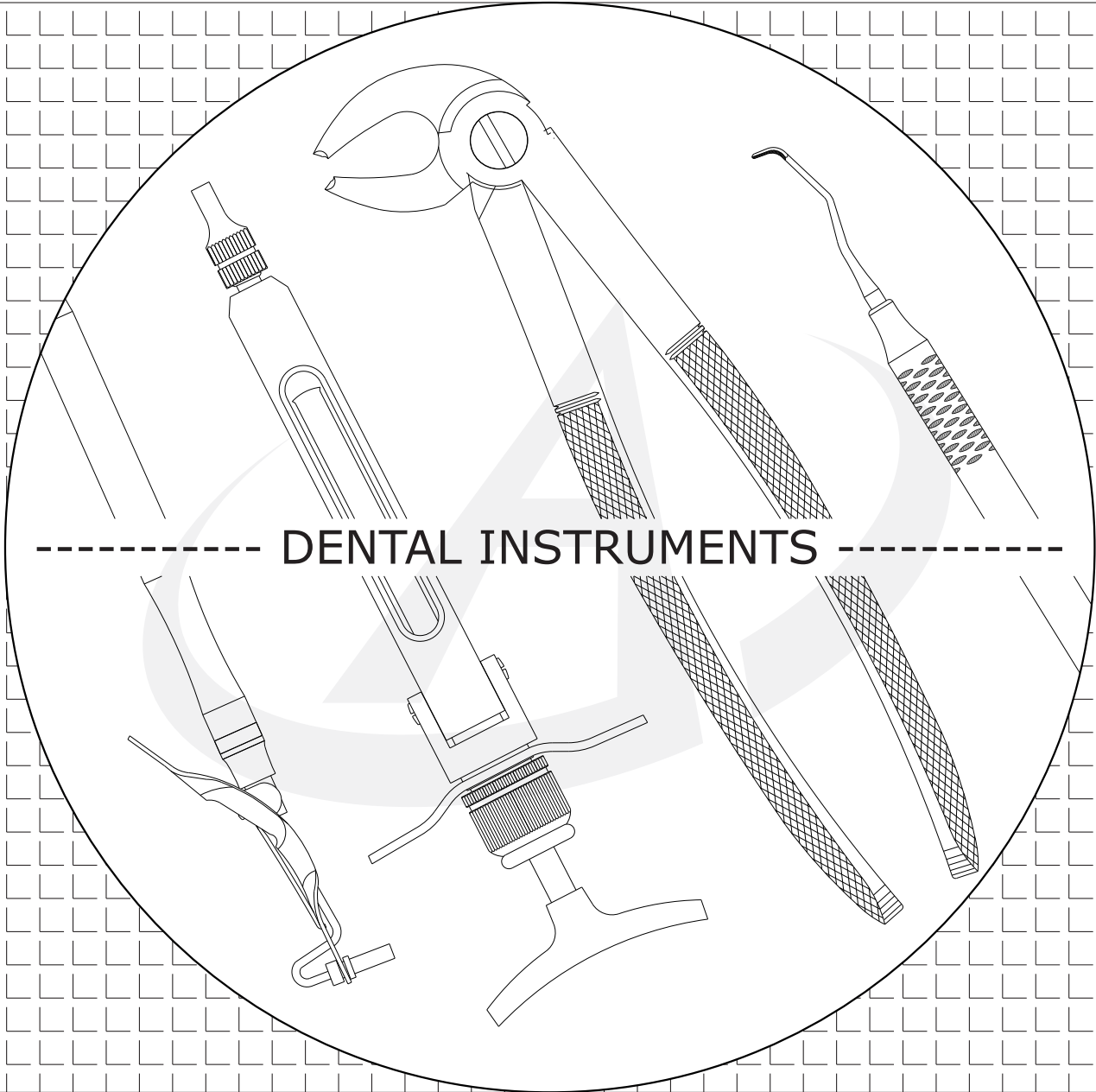

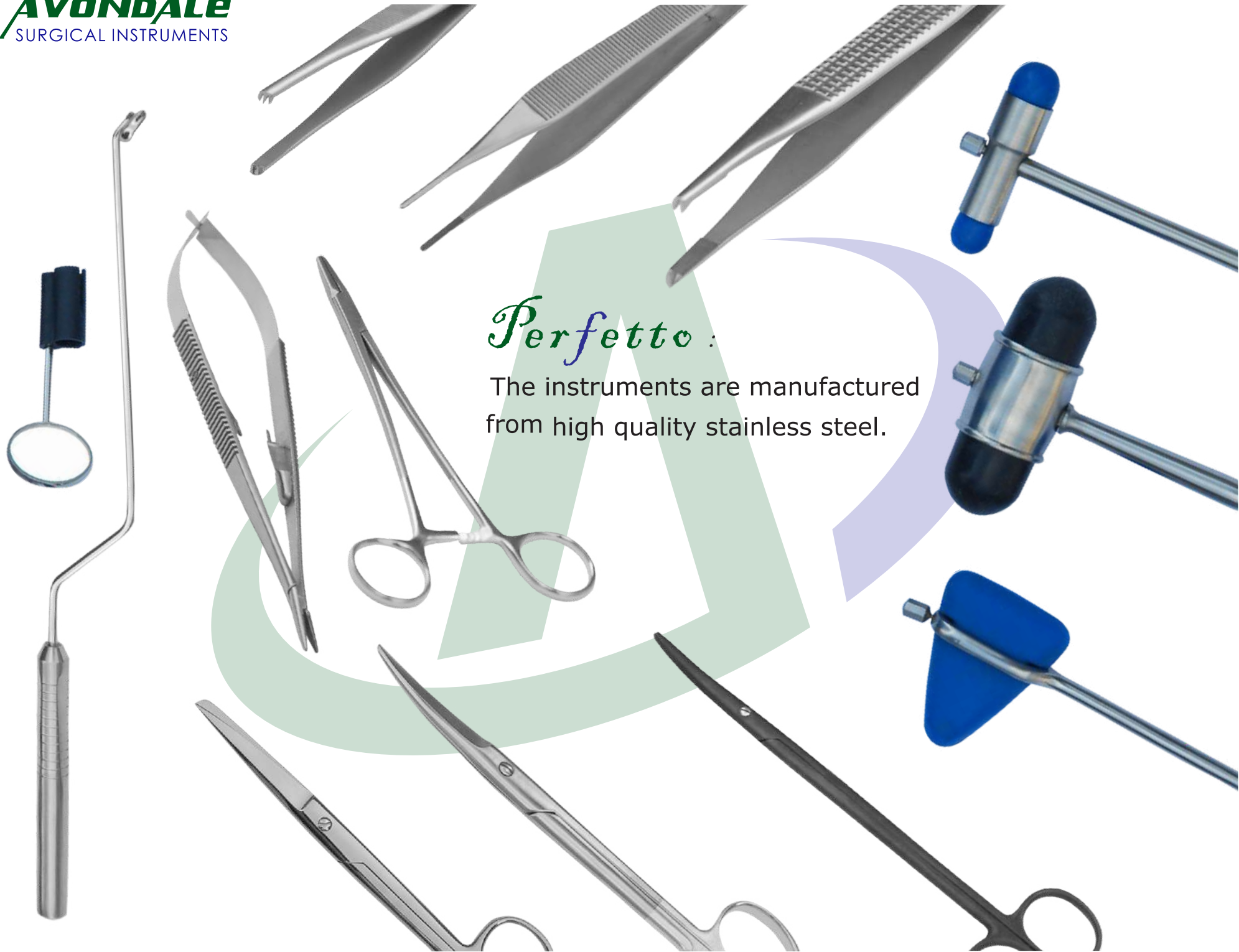

Perfetto:

The instruments are manufactured from high quality stainless steel.

Perfetto Plus : Instruments with Tungsten Carbide Insert



Perfetto Super Plus:

Titanium instrumentation designed to meet the needs of surgical procedures that require a precision featherweight touch or in a situation where only totally non-magnetic tools can be used.

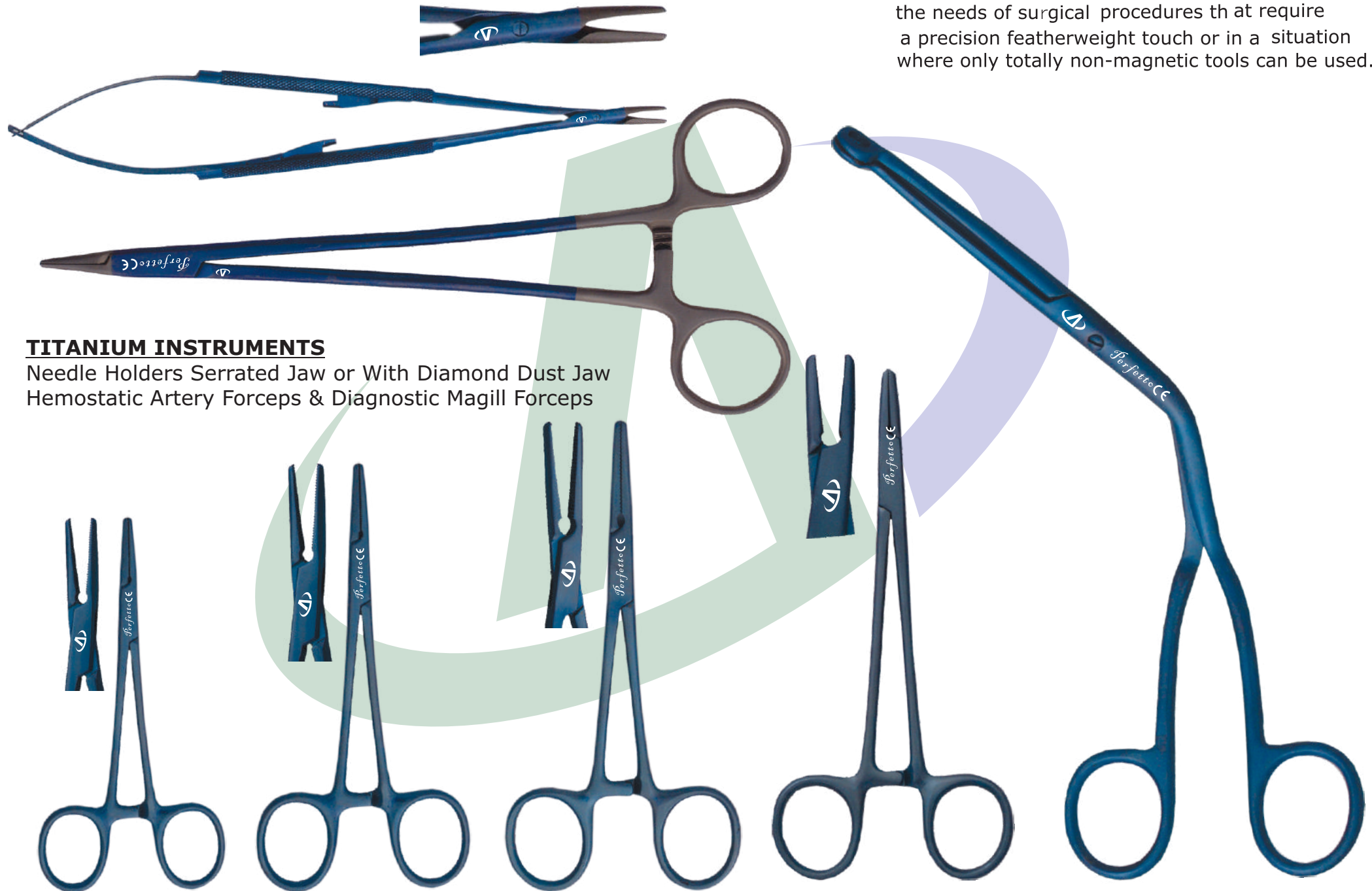

TITANIUM INSTRUMENTS

Needle Holders Serrated Jaw or With Diamond Dust Jaw
Hemostatic Artery Forceps & Diagnostic Magill Forceps

Titanium Instruments
Dissecting Forceps

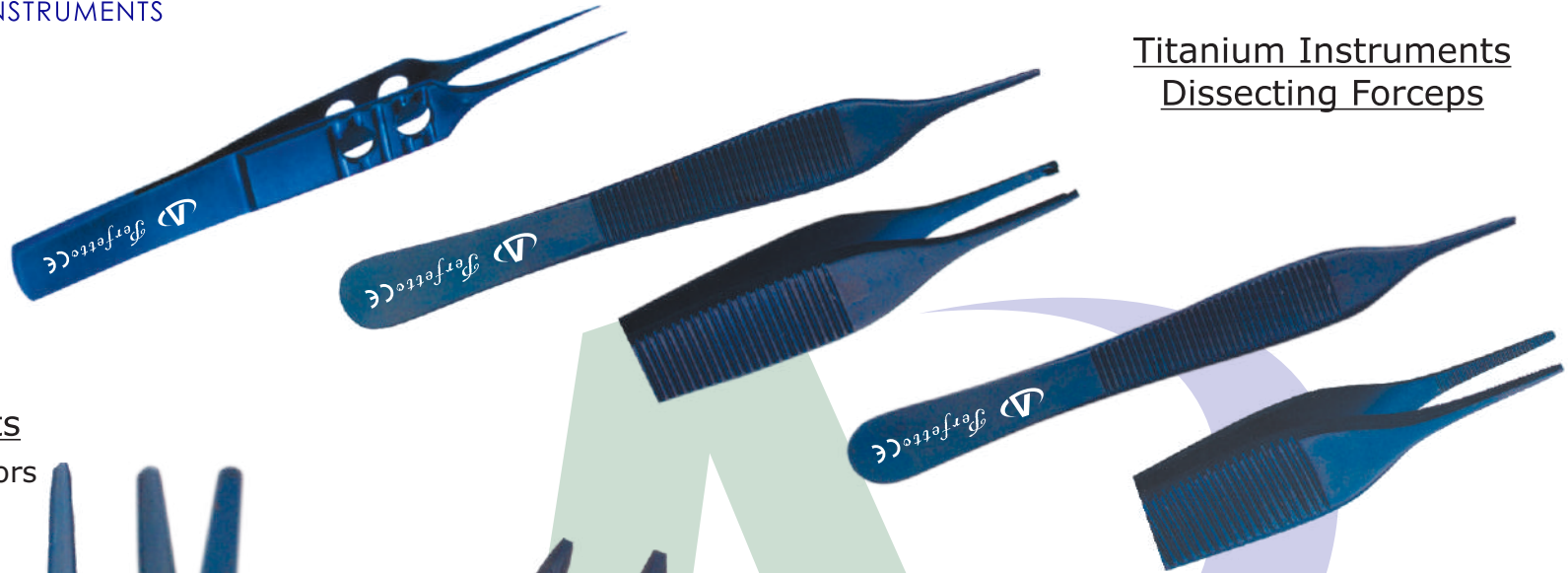

Titanium Instruments
Dissecting Dressing Scissors



Perfetto

PARKER OTOSCOPE



FEATURES

- . Pure white & cool light from Helogen lamp
- . Adjustable light intensity
- . Quick & simple bayonet fitting system
- . Re-usable or disposable speculum available
- . Designed for every day use
- . Available in soft or hard case
- . Fully guaranteed

Perfetto

PARKER OPHTHALMOSCOPE



FEATURES

- . Pure white & cool light from Helogen lamp
- . Adjustable light intensity
- . Quick & simple bayonet fitting system
- . 24 Colour coded lenses
- . - 25 to + 40 Dioptres
- . Green for + Red for -
- . Soft non latex rubber eye brow rest
- . Strong lightweight moulded head
- . Designed for every day use
- . Available in soft or hard case
- . Fully guaranteed

Perfetto

PARKER COMBI SET



COMBI SET

- 1 x Perfetto Parker Handle
- 1 x Perfetto Parker Otoscope Head
- 3 x Re-usable Aural Speculum
- 1 x Perfetto Parker Ophthalmoscope Head
- 1 x Spare Lamp
- 1 x Hard or Soft Case

Perfetto

PARKER DIAGNOSTIC SET



DIAGNOSTIC SET

- 1 x Perfetto Parker Handle
- 1 x Perfetto Parker Otoscope Head
- 3 x Re-usable Aural Speculum
- 1 x Holder for disposable Aural speculum
- 10 x Disposable speculum
- 1 x Perfetto Parker Ophthalmoscope Head
- 1 x Laryngeal Stem
- 1 x Laryngeal Mirror No. 3
- 1 x Laryngeal Mirror No. 4
- 1 x Metal Tongue Depressor
- 1 x Spare Lamp - Handle
- 1 x Spare Lamp - Stem
- 1 x Hard Case

Perfetto

MINI FIBER OPTIC OTOSCOPE



FEATURES

- . Fiber Optic illumination for a perfect view
- . Easily Carried in pocket
- . Swivelling viewing window permanently attached to prevent loss
- . Scratch resistance - giving high resolution image
- . Out put for Pneumatic membranes test
- . 2 piece construction - Handle & Head
- . Easy to maintain
- . Uses 2 x AA batteries
- . Choice of colours
- . Mini single use speculum 2.5 & 4mm (10)
- . Soft pouch

AVONDALE
SURGICAL INSTRUMENTS

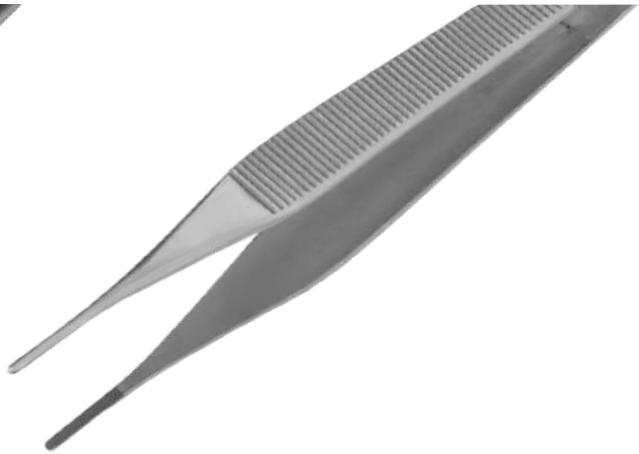
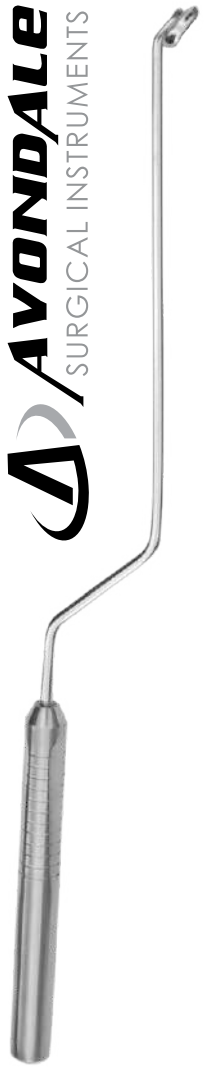

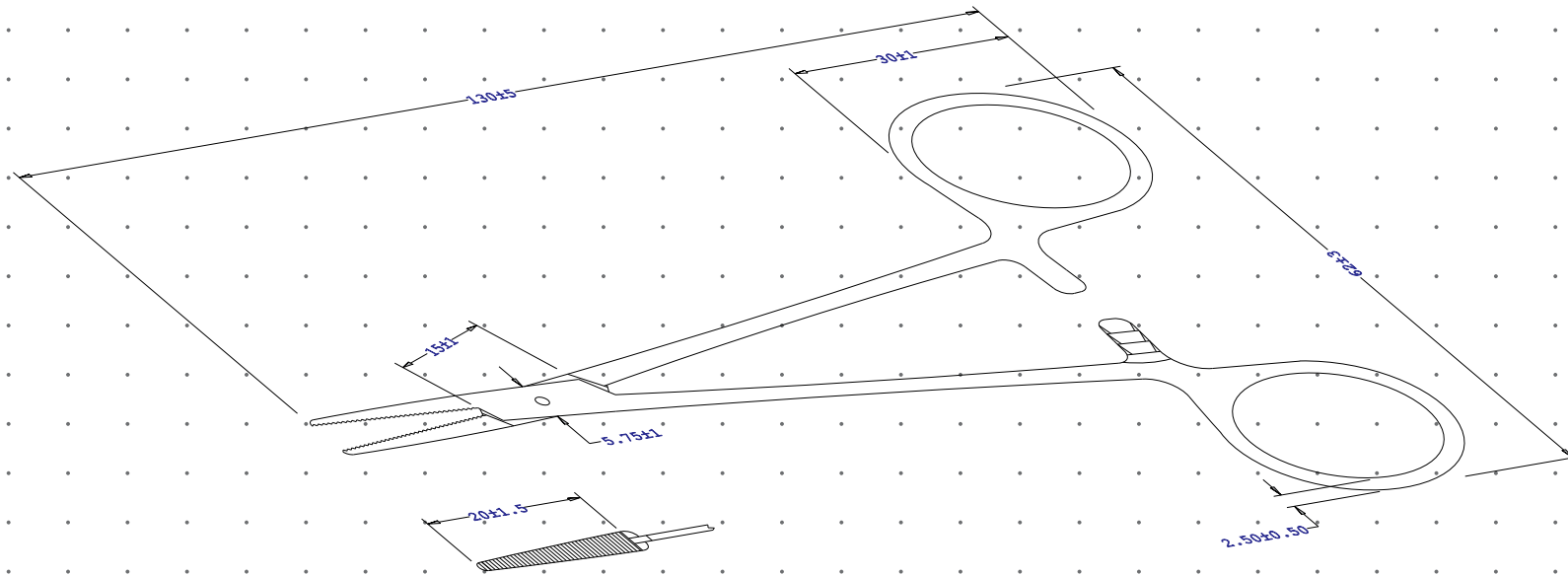

AVONDALE
SURGICAL INSTRUMENTS

16/332 Power House, Sialkot - PAKISTAN

info@avondaleinstruments.com

anjam@avondaleinstruments.com

www.avondaleinstruments.com

Mob: +92 301 619 875